

Competitors

#	Name	Club	1	Wins	Pts	Pos
1	Karina GRZYWACZ	POL/KJ Koka Jastrzebie		0	0	1

Matches

Match	White	Blue	Result	Time
-------	-------	------	--------	------

Results

Pos	Name
1	Karina GRZYWACZ POL/KJ Koka Jastrzebie

Matches

F-48

Tatami: 2, Competitors: 9

PP JUNIORÓW/EK

OPOLE
27.02.2021

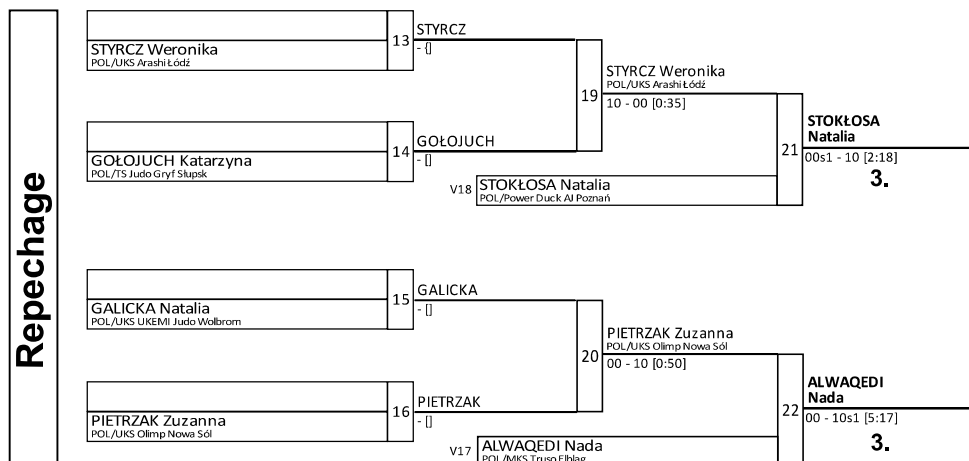
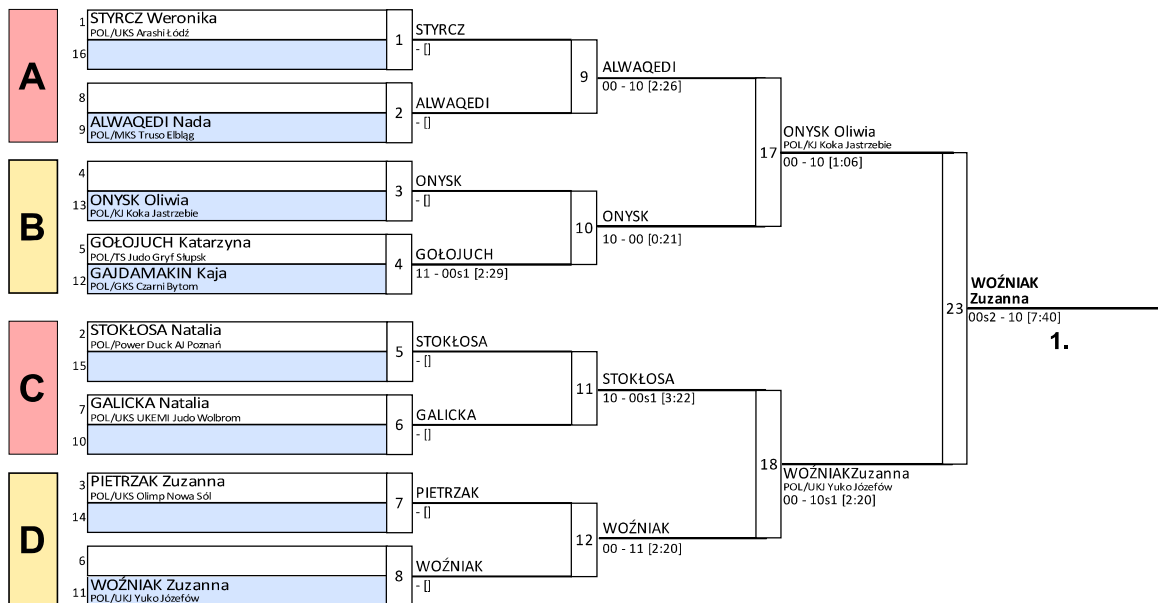

Matches

Results

Pos	Name
1	Zuzanna WOŹNIAK POL/UKJ Yuko Józefów
2	Oliwia ONYSK POL/KJ Koka Jastrzebie
3	Natalia STOKŁOSA POL/Power Duck AJ Poznań
3	Nada ALWAQEDI POL/MKS Truso Elbląg
5	Weronika STYRCZ POL/UKS Arashi Łódź
5	Zuzanna PIETRZAK POL/UKS Olimp Nowa Sól
7	Katarzyna GOŁOJUCH POL/TS Judo Gryf Słupsk
7	Natalia GALICKA POL/UKS UKEMI Judo Wolbrom

F-52

Tatami: 1, Competitors: 11

PP JUNIORÓW/EK

OPOLE
27.02.2021

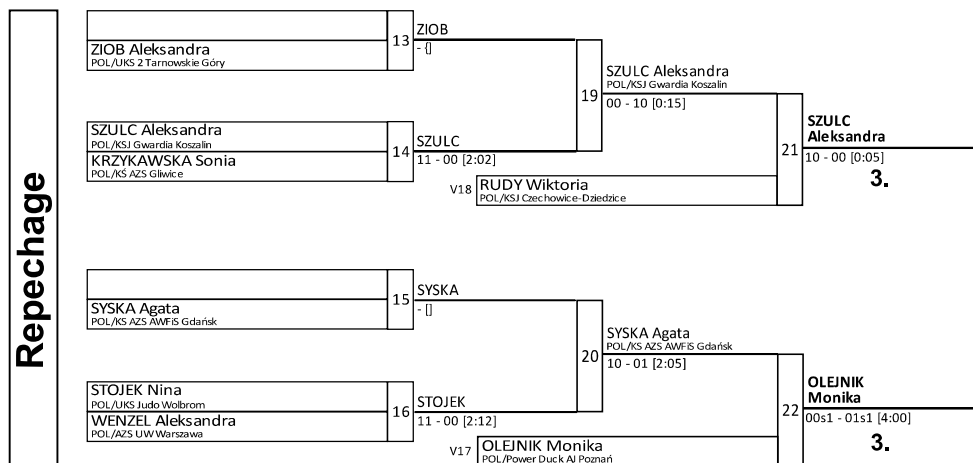
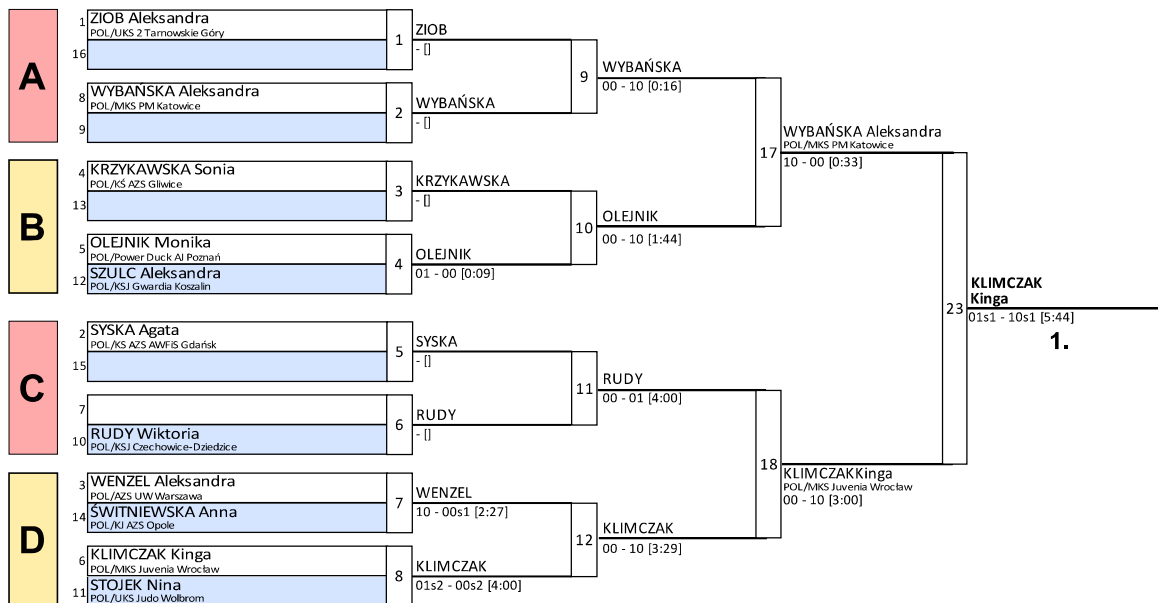

Matches

Results

Pos	Name
1	Kinga KLIMCZAK POL/MKS Juwenia Wrocław
2	Aleksandra WYBAŃSKA POL/MKS PM Katowice
3	Aleksandra SZULC POL/KSJ Gwardia Koszalin
3	Monika OLEJNIK POL/Power Duck AJ Poznań
5	Wiktoria RUDY POL/KSJ Czechowice-Dziedzice
5	Agata SYSKA POL/KS AZS AWFIS Gdańsk
7	Aleksandra ZIOB POL/UKS 2 Bimowskie Góry
7	Nina STOJEK POL/UKS Judo Wolbrom

PP JUNIORÓW/EK
OPOLE
27.02.2021

F-57

Tatami: 2, Competitors: 17

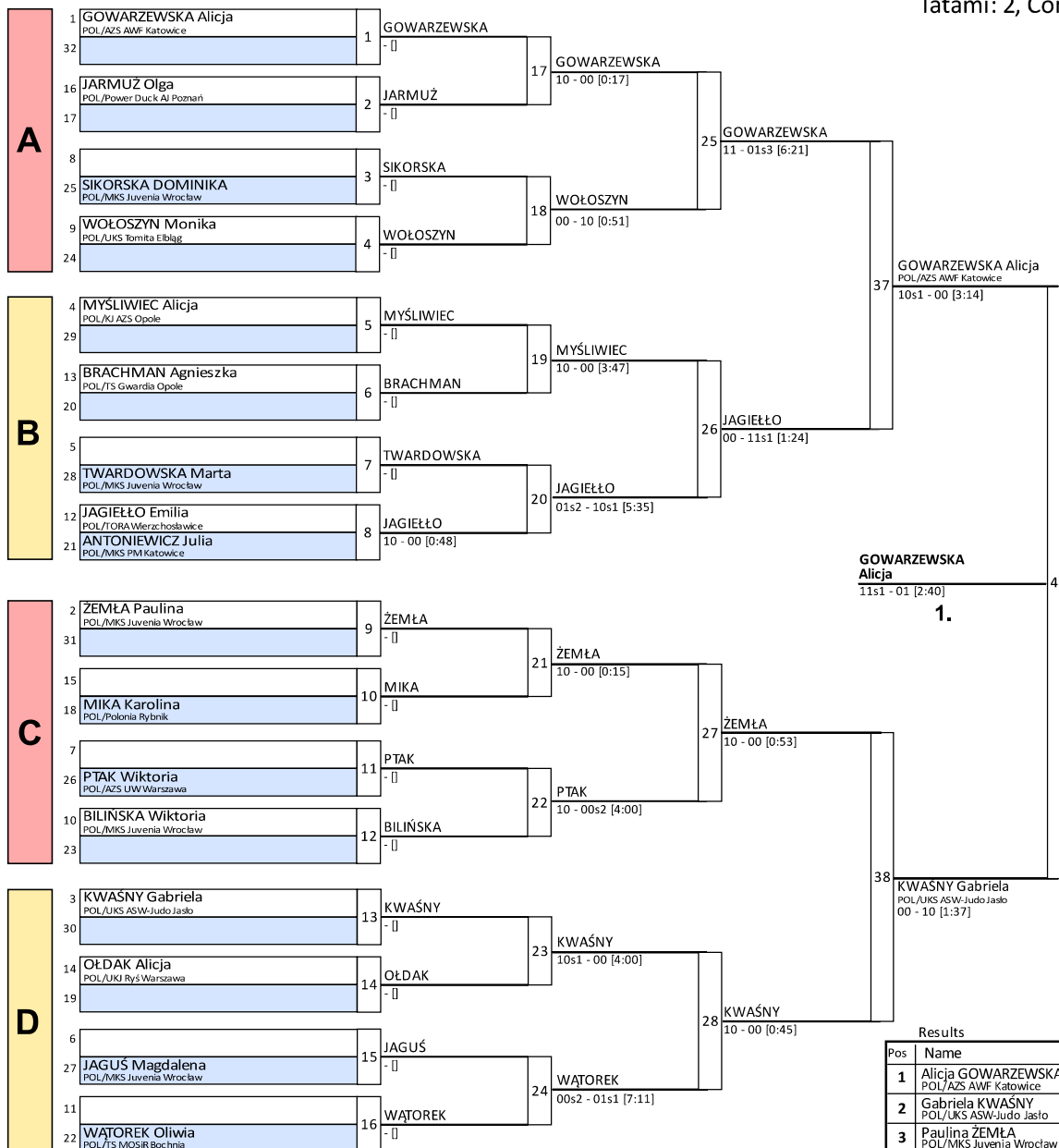

GOWARZEWSKA Alicja
11s1 - 01 [2:40]
1.

Pos	Name
1	Alicja GOWARZEWSKA POL/AZS AWF Katowice
2	Gabriela KWAŚNY POL/UKS ASW-Judo Jasko
3	Paulina ŻEMŁA POL/MKS Juwenia Wrocław
3	Emilia JAGIEŁŁO POL/TORA Wierzhosławice
5	Monika WOŁOŚZYN POL/UKS Tomita Elbląg
5	Alicja OŁDAK POL/UKJ Ryś Warszawa
7	Marta TWARDOWSKA POL/MKS Juwenia Wrocław
7	Karolina MIKA POL/Polonia Rybnik

Matches

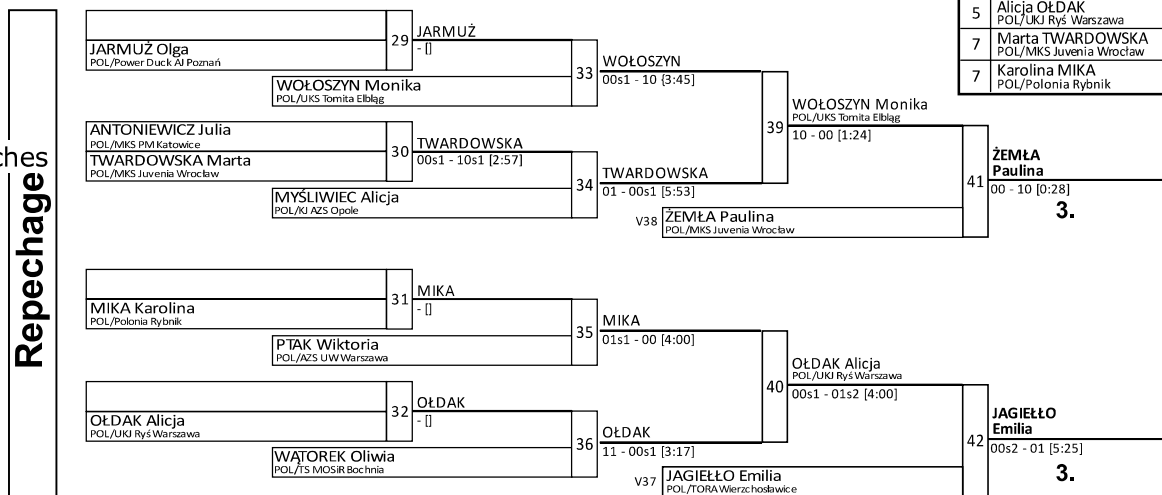

Repechage

ŻEMŁA Paulina
00 - 10 [0:28]
3.

JAGIEŁŁO Emilia
00s2 - 01 [5:25]
3.

F-70

Tatami: 2, Competitors: 11

PP JUNIORÓW/EK

OPOLE
27.02.2021

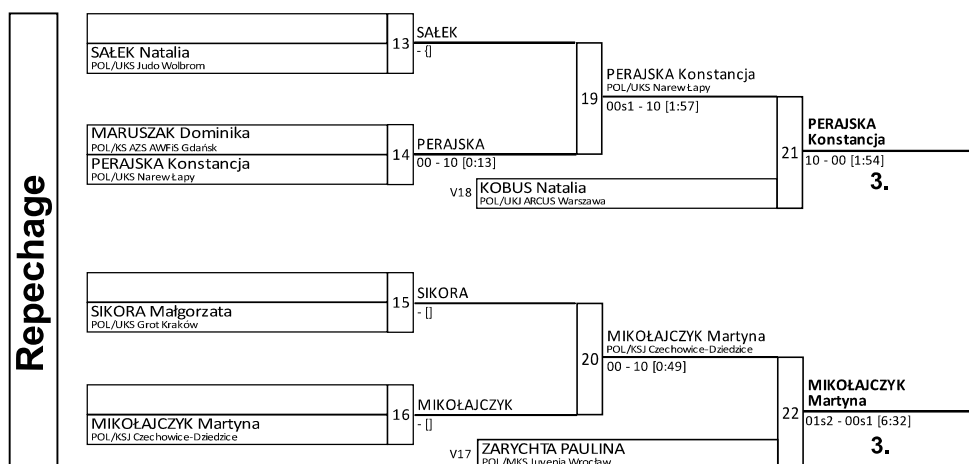
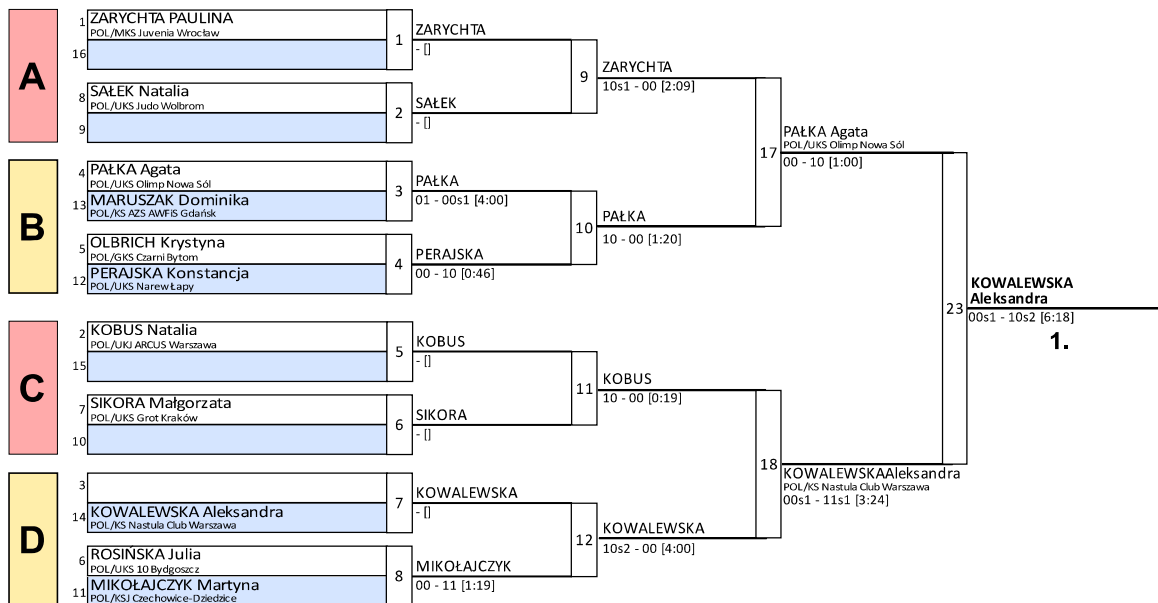

Matches

Pos	Name
1	Aleksandra KOWALEWSKA POL/KS Nastula Club Warszawa
2	Agata PAŁKA POL/UKS Olimp Nowa Sól
3	Konstancja PERAJSKA POL/UKS Narew Łapy
3	Martyna MIKOŁAJCZYK POL/KSJ Czechowice-Dziedzice
5	Natalia KOBUS POL/UKJ ARCUS Warszawa
5	PAULINA ZARYCHTA POL/MKS Juwenia Wrocław
7	Natalia SAŁEK POL/UKS Judo Wolbrom
7	Małgorzata SIKORA POL/UKS Grot Kraków

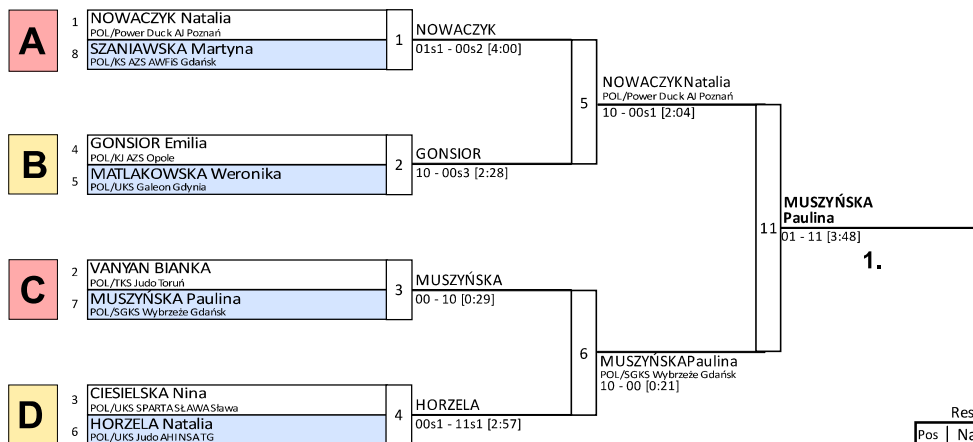

Results	
Pos	Name
1	Paulina MUSZYŃSKA POL/SGKS Wybrzeże Gdańsk
2	Natalia NOWACZYK POL/Power Duck AI Poznań
3	Martyna SZANIAWSKA POL/KS AZS AWFiS Gdańsk
3	Nina CIESIELSKA POL/UKS SPARTA SŁAWA Sława
5	Natalia HORZELA POL/UKS Judo AHINSA TG
5	Emilia GONSIOR POL/KJ AZS Opole
7	Weronika MATLAKOWSKA POL/UKS Galeon Gdynia
7	BIANKA VANYAN POL/TKS Judo Toruń

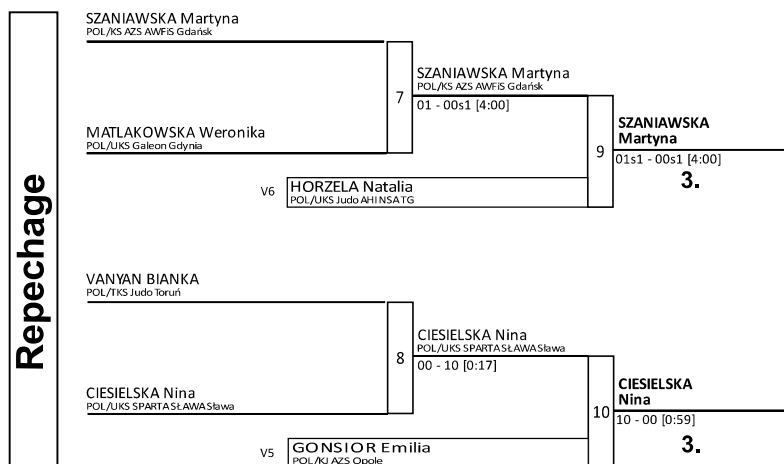

Matches

Competitors

#	Name	Club	1	2	3	Wins	Pts	Pos
1	Oliwia CEBIENIAK	POL/UKS 6 Piła		10	0	1	10	2
2	Katarzyna MIKOŁAJCZYK	POL/TS Judo Gryf Słupsk	0		0	0	0	3
3	Martyna NOLEWAJKA	POL/GKS Czarni Bytom	10	10		2	20	1

Matches

Match	White	Blue	Result	Time
1	Oliwia CEBIENIAK	1 2 Katarzyna MIKOŁAJCZYK	10 - 0	2:11
2	Oliwia CEBIENIAK	1 3 Martyna NOLEWAJKA	0 - 10	0:39
3	Katarzyna MIKOŁAJCZYK	2 3 Martyna NOLEWAJKA	0 - 10	1:24

Results

Pos	Name
1	Martyna NOLEWAJKA POL/GKS Czarni Bytom
2	Oliwia CEBIENIAK POL/UKS 6 Piła
3	Katarzyna MIKOŁAJCZYK POL/TS Judo Gryf Słupsk

Matches

M-55

Tatami: 1, Competitors: 10

PP JUNIORÓW/EK

OPOLE
27.02.2021

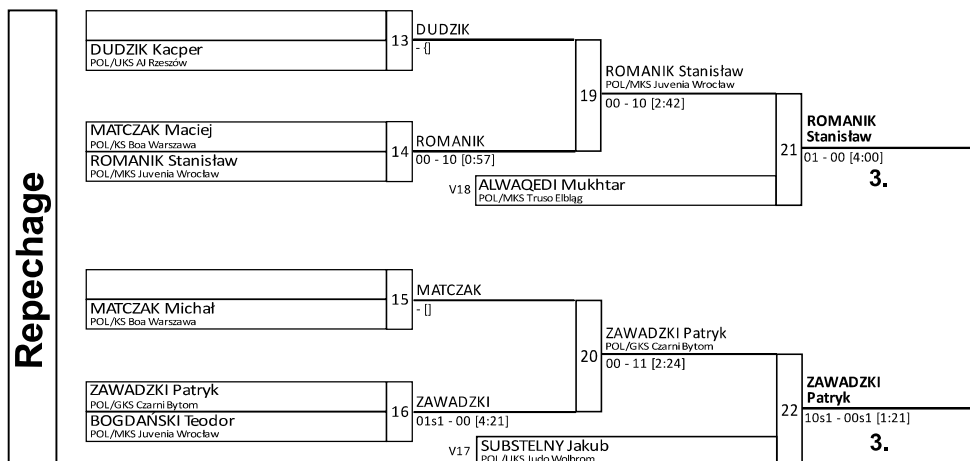
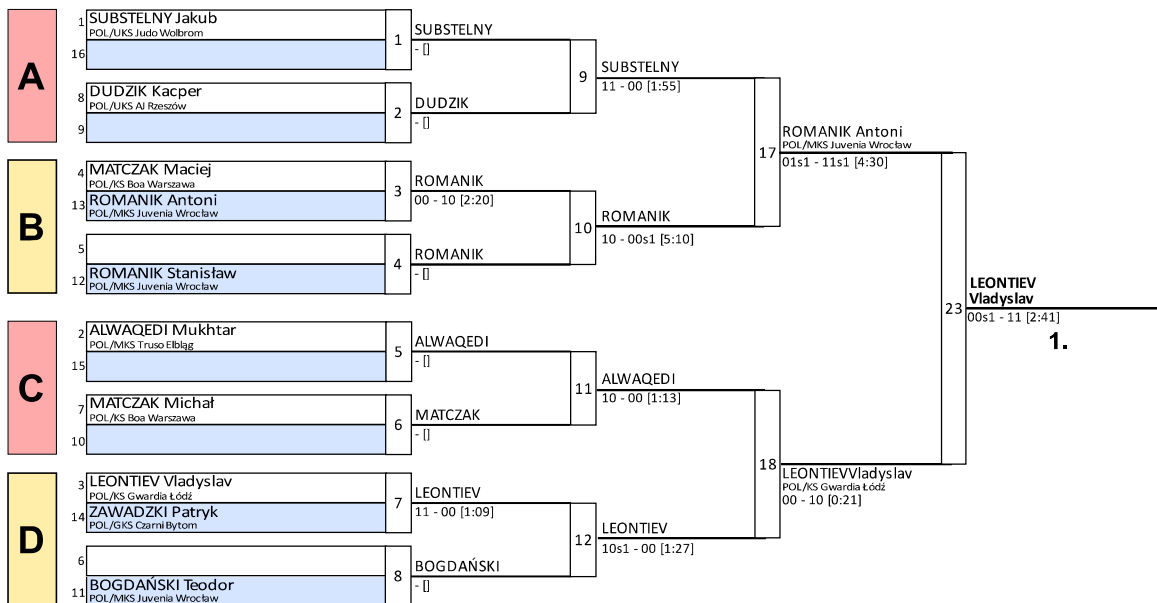

Matches

Results

Pos	Name
1	Vladyslav LEONTIEV POL/KS Gwardia Łódź
2	Antoni ROMANIK POL/MKS Juvenia Wrocław
3	Stanisław ROMANIK POL/MKS Juvenia Wrocław
3	Patryk ZAWADZKI POL/GKS Czarni Bytom
5	Mukhtar ALWAQEDI POL/MKS Truso Elbląg
5	Jakub SUBSTELNY POL/UKS Judo Wolbrom
7	Kacper DUDZIK POL/UKS AJ Rzeszów
7	Michał MATCZAK POL/KS Boa Warszawa

PP JUNIORÓW/EK
 OPOLE
 27.02.2021

M-60

Tatami: 2, Competitors: 26

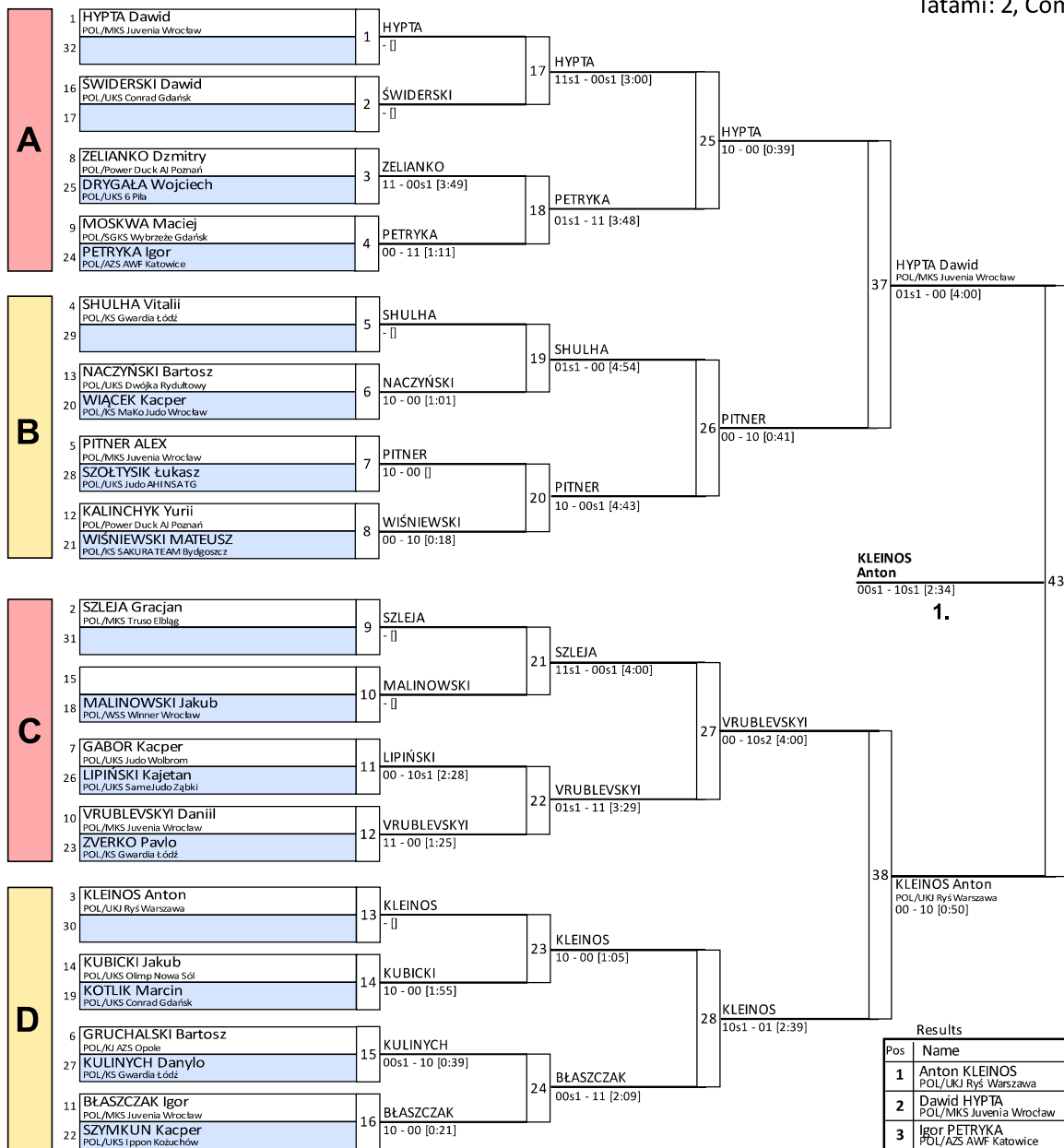

KLEINOS Anton
 00s1 - 10s1 [2:34]

1.

KLEINOS Anton
 POL/UKI Ryś Warszawa
 00 - 10 [0:50]

38

Results

Pos	Name
1	Anton KLEINOS POL/UKI Ryś Warszawa
2	Dawid HYPTA POL/MKS Juvenia Wrocław
3	Igor PETRYKA POL/AZS AWF Katowice
3	Igor BŁASZCZAK POL/MKS Juvenia Wrocław
5	Daniil VRUBLEVSKYI POL/MKS Juvenia Wrocław
5	ALEX PITNER POL/MKS Juvenia Wrocław
7	Vitalii SHULHA POL/KS Gwardia Łódź
7	Gracjan SZLEJA POL/MKS Truso Elbląg

Matches
Repechage

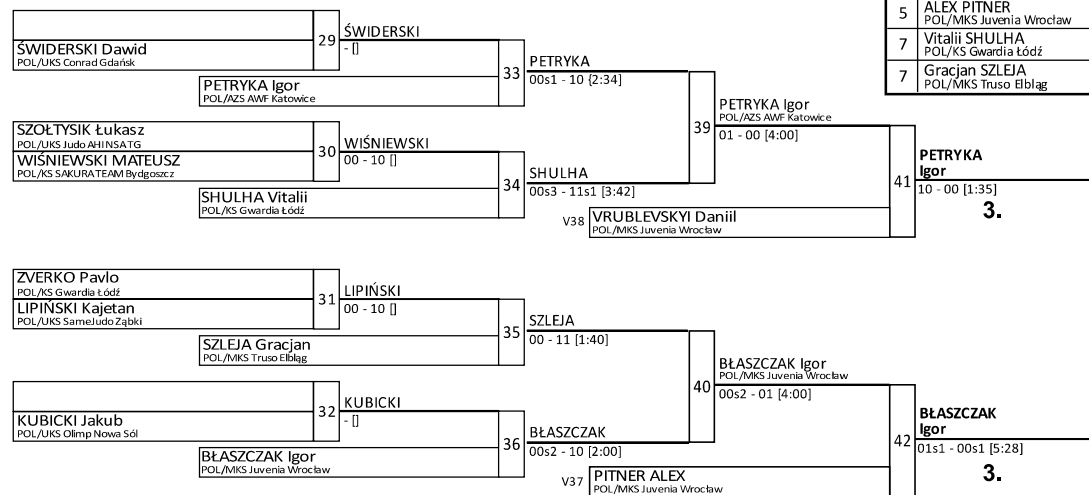

M-73

Tatami: 1, Competitors: 45
PP JUNIORÓW/EK

OPOLE
27.02.2021

A	1	RACZEK Aleksander POL/MKS Juvenia Wrocław	1	RACZEK - []	33	RACZEK 10 - 00 [0:10]	49	RACZEK 10 - 00 [0:12]	57	RACZEK 10 - 00s1 [2:31]	73	RACZEK Aleksander POL/MKS Juvenia Wrocław 11 - 00 [0:38]		
	64		2	MIKODA - []										
	32		3	RUTKOWSKI 00 - 10 [0:15]	34	RUTKOWSKI 01s1 - 00s2 [4:00]								
	33	MIKODA Konrad POL/WSS Włocławek	4	BUNKIEWICZ 10s1 - 00s2 [6:28]										
	16	NOWAK Maksymilian POL/UKS 10 Bydgoszcz	5	CHROMIK - []	35	JESIOTR 00s1 - 10 [3:54]	50	TARKOWSKI 00 - 01 [4:00]						
	49	RUTKOWSKI Paweł POL/MKS PMTarnów	6	JESIOTR - []										
	17	BUNKIEWICZ Adam POL/KJ AZS Opole	7	TARKOWSKI 10 - 00s2 [3:30]	36	TARKOWSKI 10 - 00s1 [5:20]								
	48	HALSTIAN Edhar POL/UKS Gwardia Łódź	8	PAWLICZAK 10s2 - 00s3 [5:53]										
8	CHROMIK Grzegorz POL/UKS 2 Tarnowskie Góry	B	4	WITKOWSKI Jakub POL/Judo Legia Warszawa	9	WITKOWSKI - []	37	WITKOWSKI 11 - 00 [0:43]	51	WITKOWSKI 01 - 00s1 [4:00]	58	KRÓL 00 - 10 [2:36]	73	RACZEK Aleksander POL/MKS Juvenia Wrocław 11 - 00 [0:38]
57			61		10	KOK - []								
25			29		11	KNAPIK - []	38	MATYJA 00 - 10 [2:41]						
40	JESIOTR Michał POL/UKJ Yuko Józefów		36	KOK Szymon POL/UKS Grot Kraków	12	MATYJA - []								
9	TARKOWSKI Fabrycjusz POL/KJ AZS Opole		5	SYNAK Ksawery POL/UKS KOSAI Judo Elbląg	13	DZIERZEK 00 - 10 [1:31]	39	WITALIS 00 - 10s2 [2:21]	52	KRÓL 00 - 10 [3:05]				
56	LEPIANKA Bartosz POL/UKJ Lemur Warszawa		60	DZIERZEK Konrad POL/UKS Narew Łapy	14	WITALIS 00s2 - 10s2 [2:00]	40	KRÓL 10s1 - 00s1 [2:36]						
24	PAWLICZAK Szymon POL/UKS AJ Rzeszów		28	SŁOWAK Borys POL/UKS KUZUSHI Kielce	15	KRÓL 00 - 10 [1:15]								
41	BŁASIK Wiktor POL/UKS Judo Wolbrom		37	WITALIS Wojciech POL/UKS Czarni Bytom	16	FILIPOWICZ 00s2 - 01s1 [7:14]								
C	2	KOWALSKI Marcin POL/UKJ Lemur Warszawa	17	KOWALSKI - []	41	KOWALSKI 10 - 00 [0:39]	53	PIETRAS 00 - 10 [3:15]	59	PIETRAS 11 - 00s1 [2:42]	74	KOZŁOWSKI Mateusz POL/KJ AZS Opole 00s3 - 10 [2:19]		
	63		18	ORSZULIK - []										
	31		34	ORSZULIK Dominik POL/KJ Koka Jastrzębie	19	PIETRAS 00 - 01 [4:00]	42	PIETRAS 10 - 00 [1:23]						
	34		15	PAS DOMINIK POL/MKS Juvenia Wrocław	20	PINTARA 10 - 00 [0:26]								
	50	PIETRAS Dawid POL/MKS PMŁódź	18	PINTARA Radosław POL/UKJ Był Warszawa	21	STARZYK - []	43	STARZYK 10 - 00 [2:27]	54	STARZYK 10s2 - 01s1 [3:52]				
	18	PINTARA Radosław POL/UKJ Był Warszawa	47	MAGDZIŃSKI Krzysztof POL/KJ Samuraj Koszalin	22	BŁACHA - []								
	7	STARZYK Hubert POL/MKS PMTarnów	58		23	GROJEC - []	44	BEDNAREK 00 - 10 [3:55]						
	58		26	BŁACHA Mateusz POL/KJ Koka Jastrzębie	24	BEDNAREK - []								
D	10		3	KOZŁOWSKI Mateusz POL/KJ AZS Opole	25	KOZŁOWSKI - []	45	KOZŁOWSKI 10 - 00 [0:10]	55	KOZŁOWSKI 10s1 - 00s2 [5:47]	60	KOZŁOWSKI 10 - 01s2 [3:21]		
	30		62		26	BOGDANSKI - []								
	34		30	BOGDANSKI FILIP POL/MKS Juvenia Wrocław	27	KOWALCZYK - []	46	KOWALCZYK 01s1 - 00s1 [4:27]						
	14		51	KOWALCZYK Michał POL/UKJ Ryś Warszawa	28	STRZELCZYK 00 - 10 [0:39]								
	19	VASYLIUSHKO Yaroslav POL/UKS Gwardia Łódź	16	STRZELCZYK Mikołaj POL/Judo Legia Warszawa	29	BĘTKOWSKI - []	47	ŻMUDA 00s1 - 11s1 [3:40]	56	POPAL 00 - 10 [2:56]				
	46	STRZELCZYK Mikołaj POL/Judo Legia Warszawa	6	BĘTKOWSKI Antoni POL/UKS KUZUSHI Kielce	30	ŻMUDA - []								
	59		27		31	POPAL 10 - 00 [0:21]	48	POPAL 10 - 00s1 [1:46]						
	27		38	ŻMUDA Aleksander POL/UKS Tomita Elbląg	11	POPAL Adrian POL/UKS Judo Panfil Warszawa	54	RAWIAK Mikołaj POL/WSS Włocławek						
43	KALAMUCKI Szymon POL/MKS PM Katowice	23	SYPIŃSKI Patryk POL/KJ Samuraj Koszalin	32	SYPIŃSKI 10 - 00 [0:57]									

M-73

Tatami: 1, Competitors: 45
PP JUNIOROW/EK

OPOLE
27.02.2021

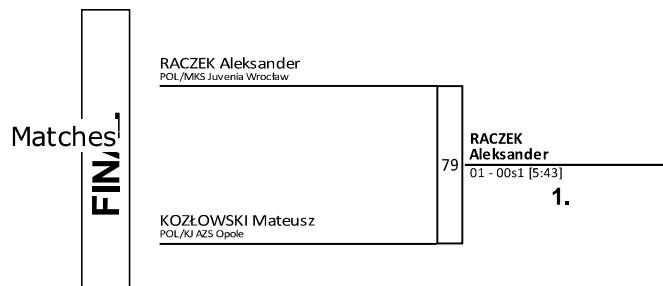
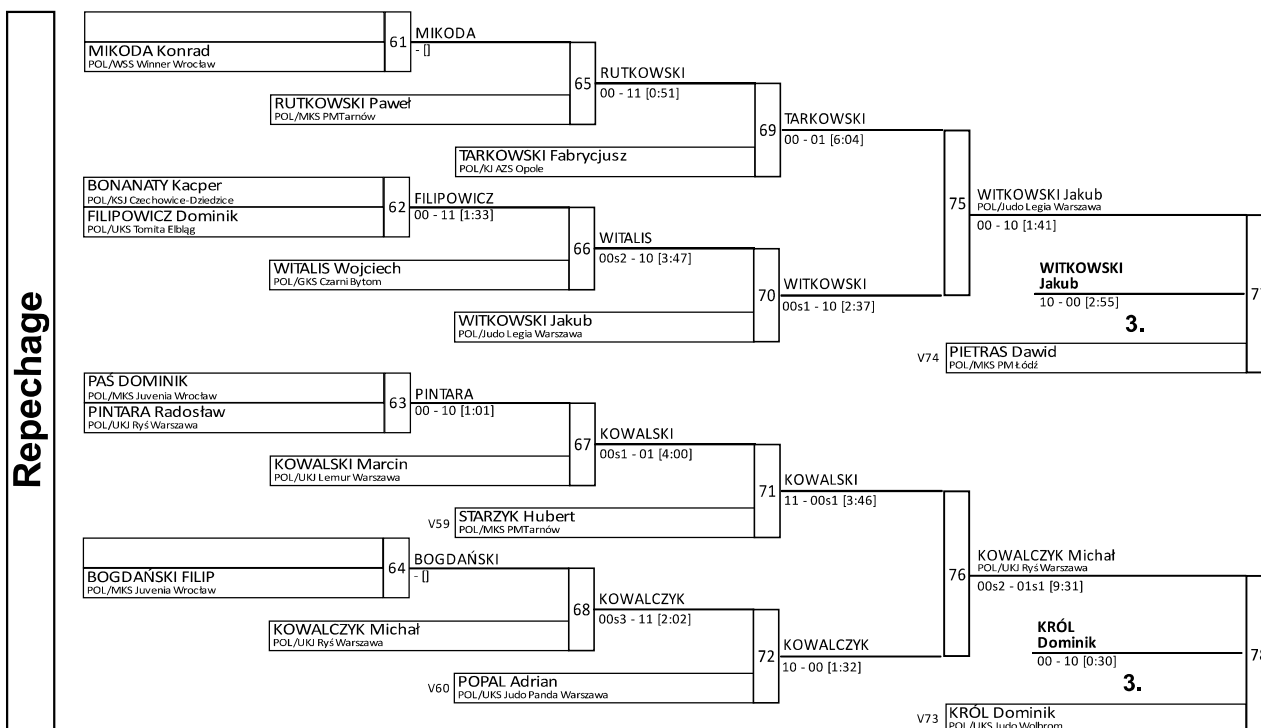

Pos	Name
1	Aleksander RACZEK POL/MKS Juvenia Wrocław
2	Mateusz KOZŁOWSKI POL/KJ AZS Opole
3	Jakub WITKOWSKI POL/Judo Legia Warszawa
3	Dominik KRÓL POL/UKS Judo Wolbrom
5	Dawid PIETRAS POL/MKS PM Łódź
5	Michał KOWALCZYK POL/UKJ Rys Warszawa
7	Fabrycjusz TARKOWSKI POL/KJ AZS Opole
7	Marcin KOWALSKI POL/UKJ Lemur Warszawa

M-81

Tatami: 2, Competitors: 33
PP JUNIORÓW/EK

OPOLE
27.02.2021

A	1	TEREKHOV Ivan POL/KS Gwardia Łódź	1	TEREKHOV - []	33	TEREKHOV 10s1 - 01 [2:44]	49	TEREKHOV 10 - 00 [0:54]	57	TEREKHOV 01s2 - 00s2 [4:32]	73	MAJEWSKI Adam POL/UJKi ASzWoj Warszawa 00s1 - 11 [1:54]
	64											
	32	ZAWIDZKI Jan POL/UJKi Ryś Warszawa	2	ZAWIDZKI - []								
	33											
	16	PRYMAS Tomasz POL/GKS Czarni Bytom	3	PRYMAS - []								
	49											
	17											
	48	ŚWITALSKI Daniel POL/SOKS Wybrzeże Gdańsk	4	ŚWITALSKI - []	34	ŚWITALSKI 00 - 10 [0:21]						
8	WAŚIKOWSKI Michał POL/Judo Legia Warszawa	5	WAŚIKOWSKI - []	35	WAŚIKOWSKI 10 - 00 [1:28]	50	WAŚIKOWSKI 10 - 00s2 [3:57]					
57												
25	DANIŁOWSKI Kacper POL/AZS-UKW/Bydgoszcz	6	DANIŁOWSKI - []									
40												
9	WŁOKA Marcin POL/AZS AWF Katowice	7	WŁOKA - []	36	ZIELASKOWSKI 00 - 11 [2:16]							
56	ZIELASKOWSKI Wiktor POL/TKS Judo Toruń	8	ZIELASKOWSKI 10 - 00 [0:58]									
24	ZALAS DAWID POL/TKS Juwenia Wrocław											
41												
B	4	OSTAFIŃSKI Jakub POL/UKS Arashi Łódź	9	OSTAFIŃSKI - []	37	OSTAFIŃSKI 11 - 00s1 [3:57]	51	MAJEWSKI 00s1 - 01 [4:00]	58	MAJEWSKI 10 - 00s2 [2:29]	79	BORZEŃKI Bartosz 00 - 10 [3:38]
	61											
	29											
	36	MAŁECKI Adam POL/KSJ Gwardia Koszalin	10	MAŁECKI - []								
	13	MAJEWSKI Adam POL/UJKi ASzWoj Warszawa	11	MAJEWSKI - []	38	MAJEWSKI 10 - 00 [0:24]						
	52											
	20	WITKOWSKI MATEUSZ POL/UJKi Ostrowia	12	WITKOWSKI - []								
	45											
	5	LEŚNIEWSKI Mateusz POL/UJKi ARCIUS Warszawa	13	LEŚNIEWSKI - []	39	KHUDOEV 00 - 10 [0:17]	52	MAZUR 00 - 10 [0:08]				
	60											
	28											
	37	KHUDOEV MURAZ POL/GKS Olimpija Grudziądz	14	KHUDOEV - []								
	12	ŚLIWA Krzysztof POL/WSS Winner Wrocław	15	ŚLIWA - []	40	MAZUR 00s1 - 10 [3:31]						
	53											
	21	MAZUR Paweł POL/UKS Tomita Elbląg	16	MAZUR - []								
	44											
C	2	KOS Kamil POL/WKS Gwardia Warszawa	17	KOS - []	41	EIDUKS 00s2 - 10s1 [5:17]	53	EIDUKS 10s1 - 00s1 [3:32]	59	BORZEŃKI 00 - 10 [2:32]	74	BORZEŃKI Bartosz POL/UJKi Ryś Warszawa 10 - 00 [0:59]
	63											
	31											
	34	EIDUKS Aleksander POL/AZS UW Warszawa	18	EIDUKS - []								
	15											
	50	ZIELIŃSKI Jacek POL/Judo Legia Warszawa	19	ZIELIŃSKI - []	42	ZIELIŃSKI 10 - 00 [0:33]						
	18	NOKIELSKI Nikodem POL/GKS Czarni Bytom	20	NOKIELSKI - []								
	47											
	7	SZULC Wojciech POL/KSJ Gwardia Koszalin	21	SZULC - []	43	BORZEŃKI 00 - 10 [1:10]	54	BORZEŃKI 11 - 00s1 [2:59]				
	58											
26	BORZEŃKI Bartosz POL/UJKi Ryś Warszawa	22	BORZEŃKI - []									
39												
10	OLSZEWSKI DAWID POL/MKS Juwenia Wrocław	23	OLSZEWSKI - []	44	ROGALSKI 00s1 - 11 [2:19]							
55												
23	ROGALSKI Oskar POL/Judo Legia Warszawa	24	ROGALSKI - []									
42												
D	3	MUSZYŃSKI PIOTR POL/KS AI POZNAŃ	25	MUSZYŃSKI - []	45	MUSZYŃSKI 11s1 - 00s1 [2:09]	55	MUSZYŃSKI 10 - 00s1 [1:51]	60	MUSZYŃSKI 11 - 00 [1:43]		
	62											
	30	JANKOWSKI Aleksander POL/KS Start Radom	26	JANKOWSKI - []								
	35											
	14	RAWIAK Lucjan POL/WSS Winner Wrocław	27	RAWIAK - []	46	KIELESIŃSKI 00s1 - 10 [1:23]						
	51											
	19											
	46	KIELESIŃSKI Jakub POL/Judo Legia Warszawa	28	KIELESIŃSKI - []								
	6	PRUSS Maksymilian POL/TKS Judo Toruń	29	PRUSS - []	47	PRUSS 10s1 - 00 [2:06]	56	RYBICKI 00s1 - 01 [4:11]				
	59											
	27	AMBROŹY Bartosz POL/UJKS Orkan Sochaczew	30	AMBROŹY - []								
38												
11												
54	RYBICKI Sebastian POL/UJKS Judo Sensei St. Prob.	31	RYBICKI - []	48	RYBICKI 01s2 - 00 [4:00]							
22												
43	MIZIN Władysław POL/KS Gwardia Łódź	32	MIZIN - []									

M-81

Tatami: 2, Competitors: 33
PP JUNIOROW/EK

OPOLE
27.02.2021

Repechage

ZAWIDZKI Jan POL/UJKI Rys Warszawa	61	ZAWIDZKI - []	65	ZAWIDZKI 10 - 00 [0:27]	69	WAŚKOWSKI 00 - 10 [5:56]	75	OSTAFIŃSKI Jakub POL/UJKS Arashi Łódź	00s3 - 10s2 [3:19]	77	MUSZYŃSKI PIOTR 00s2 - 11s1 [3:47]	3.
SWITALSKI Daniel POL/SGKS Wybrzeże Gdańsk												
WITKOWSKI MATEUSZ POL/UJKS Ostrowa	62	WITKOWSKI - []	66	OSTAFIŃSKI 00s2 - 01s1 [4:08]	70	OSTAFIŃSKI 10 - 00 [1:36]						
OSTAFIŃSKI Jakub POL/UJKS Arashi Łódź												
MAZUR Paweł POL/UJKS Toruń Elbląg												
SZULC Wojciech POL/UJKS Gwardia Koszalin	63	SZULC - []	67	SZULC 10 - 00 []	71	EIDUKS 00s1 - 10s1 [4:00]						
ROGALSKI Oskar POL/Judo Legia Warszawa												
JANKOWSKI Aleksander POL/KS Start Radom	64	JANKOWSKI - []	68	KIELESIŃSKI 00 - 11s1 [1:27]	72	KIELESIŃSKI 10 - 00s1 [3:45]	76	KIELESIŃSKI Jakub POL/Judo Legia Warszawa	00s1 - 11 [1:33]	78	KIELESIŃSKI Jakub 10 - 00 [0:44]	3.
KIELESIŃSKI Jakub POL/Judo Legia Warszawa												
RYBICKI Sebastian POL/UJKS Judo Sensei St. Prob.	V60											
EIDUKS Aleksander POL/AZS UW Warszawa	V59											
MUSZYŃSKI PIOTR POL/KS AI POZNAŃ	V74											
TEREKHOV Ivan POL/KS Gwardia Łódź	V73											

Matches

FIN

MAJEWSKI Adam POL/UJKI AS2Woj Warszawa												
BORZECKI Bartosz POL/UJKI Rys Warszawa	79	BORZECKI Bartosz 00 - 10 [3:38]										1.

Results

Pos	Name
1	Bartosz BORZECKI POL/UJKI Rys Warszawa
2	Adam MAJEWSKI POL/UJKI AS2Woj Warszawa
3	PIOTR MUSZYŃSKI POL/KS AI POZNAŃ
3	Jakub KIELESIŃSKI POL/Judo Legia Warszawa
5	Jakub OSTAFIŃSKI POL/UJKS Arashi Łódź
5	Ivan TEREKHOV POL/KS Gwardia Łódź
7	Michał WAŚKOWSKI POL/Judo Legia Warszawa
7	Aleksander EIDUKS POL/AZS UW Warszawa

M-90

Tatami: 3, Competitors: 11

PP JUNIORÓW/EK

OPOLE
27.02.2021

A	1	MECHOWSKI Dawid POL/SGKS Wybrzeże Gdańsk	1	MECHOWSKI	- []	9	MECHOWSKI	10 - 00 [0:51]	17	MECHOWSKI Dawid POL/SGKS Wybrzeże Gdańsk	10 - 00 [0:53]
	16										
B	8	MIKA Wiktor POL/KS Judo Tigers Wrocław	2	ZAWISTOWSKI	00 - 11 [1:30]	10	STUDNICKI	00s2 - 10s1 [2:05]	23	MECHOWSKI Dawid POL/SGKS Wybrzeże Gdańsk	01s1 - 00 [4:00]
	9	ZAWISTOWSKI Franek POL/UKJ Yuko Józefów									
C	4	PARDO Marcin POL/KS AZS Gliwice	3	PARDO	- []	11	JANCZYLIK	10 - 00s1 [1:28]	18	JANCZYLIK Dmitrij POL/UKS Galeon Gdynia	10 - 00s3 [1:16]
	13										
D	5	STUDNICKI Ignacy POL/AZS AWF Gorzów Wlkp.	4	STUDNICKI	10 - 00 [0:55]	12	KARCZYK	10 - 00 [2:23]	21	KARCZYK Filip POL/UKS PCS Warszawa	00 - 10 [0:46]
	12	POTERAŁA Gracjan POL/MKS Juwenia Wrocław									
C	2	JANCZYLIK Dmitrij POL/UKS Galeon Gdynia	5	JANCZYLIK	- []	11	KARCZYK	11 - 00 [1:07]	12	ŻOŁĄDZIEJEWSKI	11 - 00 [1:07]
	15										
D	7	POPIELARZ Dominik POL/GKS Czarni Bytom	6	POPIELARZ	- []	12	KARCZYK	10 - 00 [2:23]	12	ŻOŁĄDZIEJEWSKI	11 - 00 [1:07]
	10										
D	3	KARCZYK Filip POL/UKS PCS Warszawa	7	KARCZYK	- []	12	KARCZYK	10 - 00 [2:23]	12	ŻOŁĄDZIEJEWSKI	11 - 00 [1:07]
	14										
D	6	ŻOŁĄDZIEJEWSKI Bartosz POL/GSSiR Gorzów Wlkp.	8	ŻOŁĄDZIEJEWSKI	11 - 00 [1:07]	12	KARCZYK	10 - 00 [2:23]	12	ŻOŁĄDZIEJEWSKI	11 - 00 [1:07]
	11	TOMCZYK Dawid POL/KS KUZUSHI Kielce									

Repechage	13	ZAWISTOWSKI Franek POL/UKJ Yuko Józefów	13	ZAWISTOWSKI	- []	19	ZAWISTOWSKI Franek POL/UKJ Yuko Józefów	10 - 00 [0:58]	21	KARCZYK Filip POL/UKS PCS Warszawa	00 - 10 [0:46]
	14	POTERAŁA Gracjan POL/MKS Juwenia Wrocław	14	POTERAŁA	11 - 00s1 [2:32]	18	KARCZYK Filip POL/UKS PCS Warszawa	10 - 00 [0:58]	21	KARCZYK Filip POL/UKS PCS Warszawa	00 - 10 [0:46]
	14	PARDO Marcin POL/KS AZS Gliwice									
	15	POPIELARZ Dominik POL/GKS Czarni Bytom	15	POPIELARZ	- []	20	POPIELARZ Dominik POL/GKS Czarni Bytom	10 - 01s1 [1:40]	22	POPIELARZ Dominik POL/GKS Czarni Bytom	10s2 - 00s3 [2:53]
16	ŻOŁĄDZIEJEWSKI Bartosz POL/GSSiR Gorzów Wlkp.	16	ŻOŁĄDZIEJEWSKI	- []	17	STUDNICKI Ignacy POL/AZS AWF Gorzów Wlkp.	10 - 01s1 [1:40]	22	POPIELARZ Dominik POL/GKS Czarni Bytom	10s2 - 00s3 [2:53]	
16											

Matches

Results

Pos	Name
1	Dawid MECHOWSKI POL/SGKS Wybrzeże Gdańsk
2	Dmitrij JANCZYLIK POL/UKS Galeon Gdynia
3	Filip KARCZYK POL/UKS PCS Warszawa
3	Dominik POPIELARZ POL/GKS Czarni Bytom
5	Franek ZAWISTOWSKI POL/UKJ Yuko Józefów
5	Ignacy STUDNICKI POL/AZS AWF Gorzów Wlkp.
7	Gracjan POTERAŁA POL/MKS Juwenia Wrocław
7	Bartosz ŻOŁĄDZIEJEWSKI POL/GSSiR Gorzów Wlkp.

M-100

Tatami: 3, Competitors: 11

PP JUNIORÓW/EK

OPOLE
27.02.2021

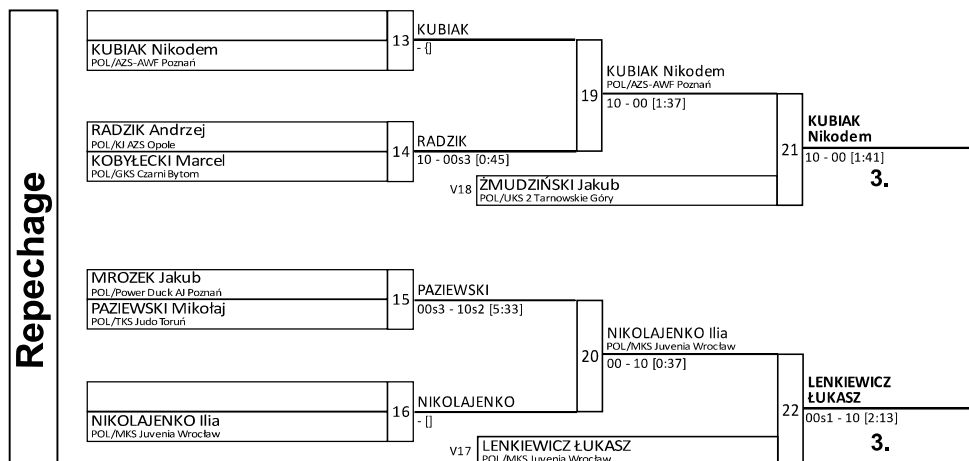
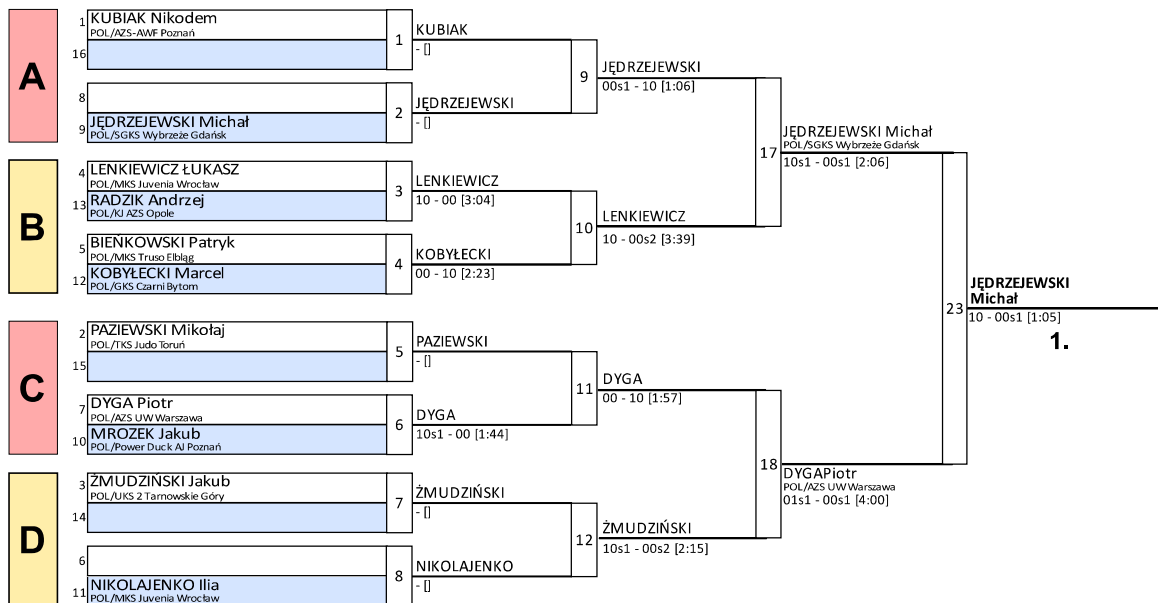

Matches

Results

Pos	Name
1	Michał JĘDRZEJEWSKI POL/SGKS Wybrzeże Gdańsk
2	Piotr DYGA POL/AZS UW Warszawa
3	Nikodem KUBIAK POL/AZF-AWF Poznań
3	ŁUKASZ LENKIEWICZ POL/MKS Juwenia Wrocław
5	Jakub ŻMUDZIŃSKI POL/UKS 2 Tarnowskie Góry
5	Ilija NIKOLAJENKO POL/MKS Juwenia Wrocław
7	Andrzej RADZIK POL/KJ AZS Opole
7	Mikołaj PAZIEWSKI POL/TKS Judo Toruń

M+100

Tatami: 3, Competitors: 10

PP JUNIORÓW/EK

OPOLE
27.02.2021

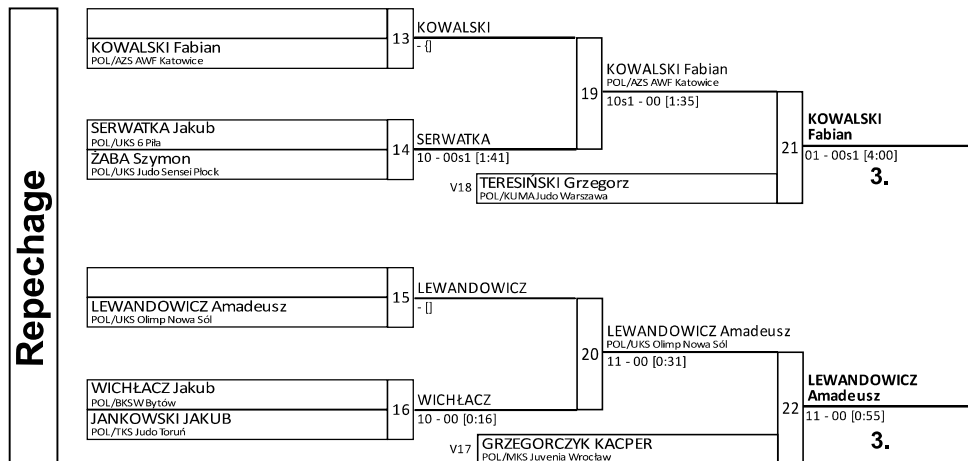
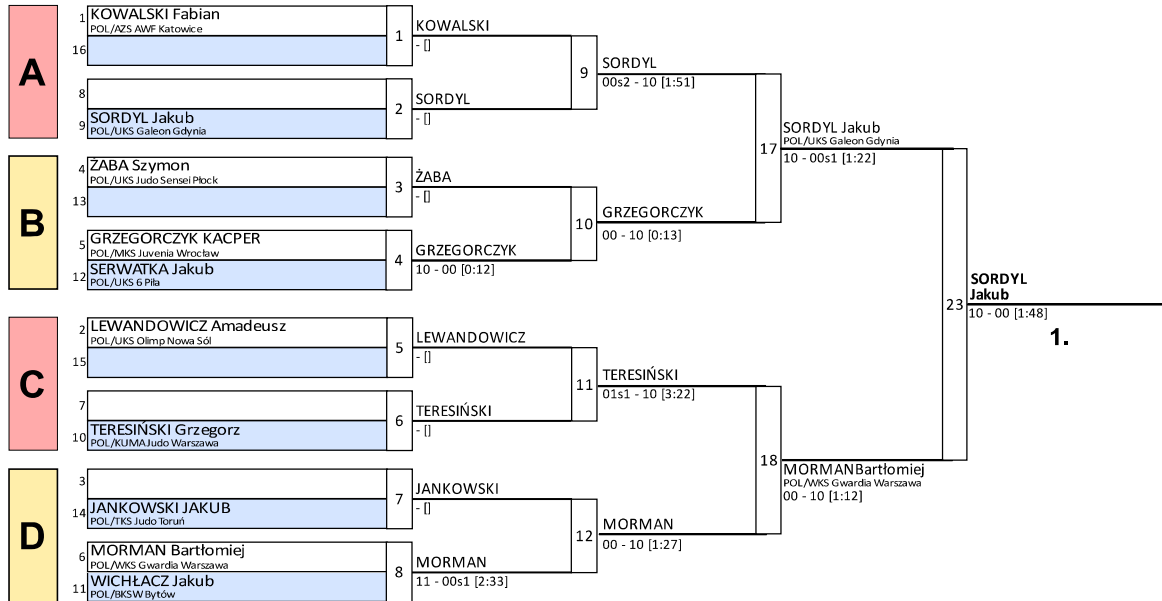

Matches

Results

Pos	Name
1	Jakub SORDYL POL/UKS Galeon Gdynia
2	Bartłomiej MORMAN POL/WKS Gwardia Warszawa
3	Fabian KOWALSKI POL/AZS AWF Katowice
3	Amadeusz LEWANDOWICZ POL/UKS Olimp Nowa Sól
5	Grzegorz TERESIŃSKI POL/KUMA Judo Warszawa
5	KACPER GRZEGORCZYK POL/MKS Juwenia Wrocław
7	Jakub SERWATKA POL/UKS 6 Pila
7	Jakub WICHŁACZ POL/BKSW Bytów